

超小型、低功耗 1KSPS、24 位 ADC

1 特性

- 宽电源电压：2.7V 至 5.5V
- 低功耗：150uA（连续转换模式）
- 可编程数据传输速率：6.25SPS 至 1K SPS
- 单周期稳定
- 内部低漂移电压基准
- 内部振荡器
- I2C 接口：四个引脚可选地址
- 四个单端输入或两个差分输入
- 可编程比较器
- 工作温度范围：-40°C 至 +125°C

2 应用

- 便携式仪表
- 电池电压和电流监控
- 温度测量系统
- 消费类电子产品
- 工厂自动化和过程控制

3 概述

GD30AD3640 器件是兼容 I2C 的 16 位高精度低功耗模数转换器 (ADC)，采用小型 DFN-10 封装和 MSOP-10 封装。GD30AD3640 器件集成了低漂移电压基准和振荡器。GD30AD3640 还包括可编程增益放大器 (PGA) 和数字比较器。这些特性加以较宽的工作电源电压范围使得 GD30AD3640 非常适合功耗受限和空间受限的传感器测量应用。

GD30AD3640 可在数据速率高达每秒 1000 个样本 (SPS) 的情况下执行转换。PGA 可提供从 $\pm 64\text{mV}$ 到 $\pm 6.144\text{V}$ 的输入范围，从而实现精准的大小信号测量。GD30AD3640 具有一个输入多路复用器 (MUX)，可实现两对差分输入测量或四个单端输入测量。在 GD30AD3640 中可使用数字比较器进行欠压和过压检测。

GD30AD3640 既可在连续转换模式下工作，也可在单冲模式下工作。在单冲模式下，这些器件可在一次转换后自动断电；因此显著降低了空闲期间的功耗。

产品信息¹

料号	封装类型
GD30AD3640	DFN-10
	MSOP-10

简化框图

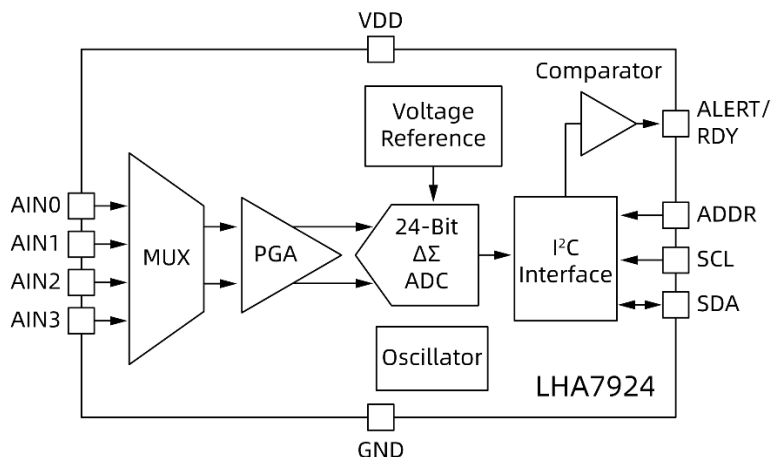

Important Notice

This document is the property of GigaDevice Semiconductor Inc. and its subsidiaries (the "Company"). This document, including any product of the Company described in this document (the "Product"), is owned by the Company according to the laws of the People's Republic of China and other applicable laws. The Company reserves all rights under such laws and no Intellectual Property Rights are transferred (either wholly or partially) or licensed by the Company (either expressly or impliedly) herein. The names and brands of third party referred thereto (if any) are the property of their respective owner and referred to for identification purposes only.

The Company makes no representations or warranties of any kind, express or implied, with regard to the merchantability and the fitness for a particular purpose of the Product, nor does the Company assume any liability arising out of the application or use of any Product described in this document. Any information provided in this document is provided only for reference purposes. It is the sole responsibility of the user of this document to determine whether the Product is suitable and fit for its applications and products planned, and properly design, program, and test the functionality and safety of its applications and products planned using the Product. Unless otherwise expressly specified in the datasheet of the Product, the Product is designed, developed, and/or manufactured for ordinary business, industrial, personal, and/or household applications only, and the Product is not designed or intended for use in (i) safety critical applications such as weapons systems, nuclear facilities, atomic energy controller, combustion controller, aeronautic or aerospace applications, traffic signal instruments, pollution control or hazardous substance management; (ii) life-support systems, other medical equipment or systems (including life support equipment and surgical implants); (iii) automotive applications or environments, including but not limited to applications for active and passive safety of automobiles (regardless of front market or aftermarket), for example, EPS, braking, ADAS (camera/fusion), EMS, TCU, BMS, BSG, TPMS, Airbag, Suspension, DMS, ICMS, Domain, ESC, DCDC, e-clutch, advanced-lighting, etc.. Automobile herein means a vehicle propelled by a self-contained motor, engine or the like, such as, without limitation, cars, trucks, motorcycles, electric cars, and other transportation devices; and/or (iv) other uses where the failure of the device or the Product can reasonably be expected to result in personal injury, death, or severe property or environmental damage (collectively "Unintended Uses"). Customers shall take any and all actions to ensure the Product meets the applicable laws and regulations. The Company is not liable for, in whole or in part, and customers shall hereby release the Company as well as its suppliers and/or distributors from, any claim, damage, or other liability arising from or related to all Unintended Uses of the Product. Customers shall indemnify and hold the Company, and its officers, employees, subsidiaries, affiliates as well as its suppliers and/or distributors harmless from and against all claims, costs, damages, and other liabilities, including claims for personal injury or death, arising from or related to any Unintended Uses of the Product.

Information in this document is provided solely in connection with the Product. The Company reserves the right to make changes, corrections, modifications or improvements to this document and the Product described herein at any time without notice. The Company shall have no responsibility whatsoever for conflicts or incompatibilities arising from future changes to them. Information in this document supersedes and replaces information previously supplied in any prior versions of this document.

© 2023 GigaDevice – All rights reserved